

## Welded Pocket Frame Detail (Including Sub-Frame ) 1 of 2

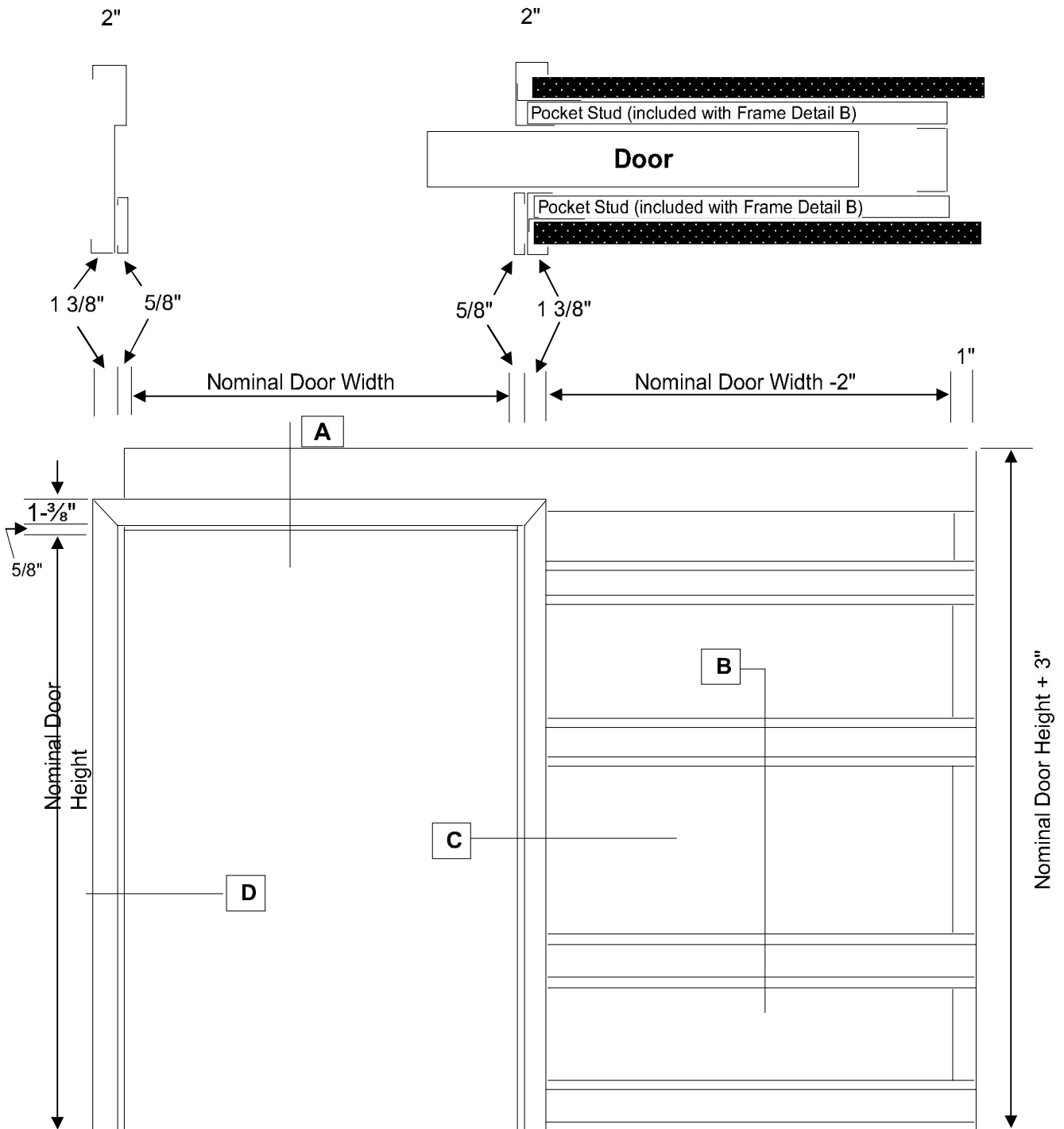

## Welded Pocket Frame Detail (Including Sub-Frame ) 2 of 2

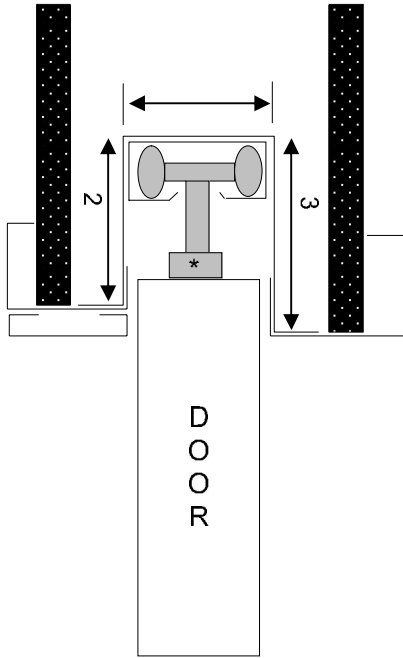

A - Head Detail

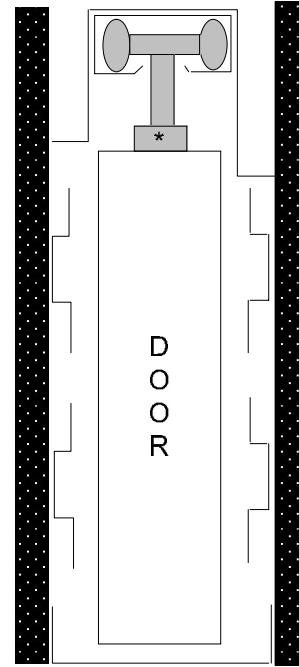

B - Pocket Detail Side View

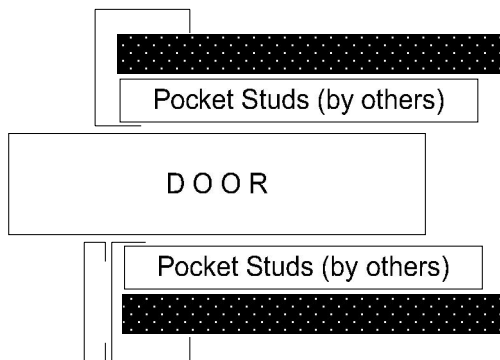

C - Pocket / Receiver Detail

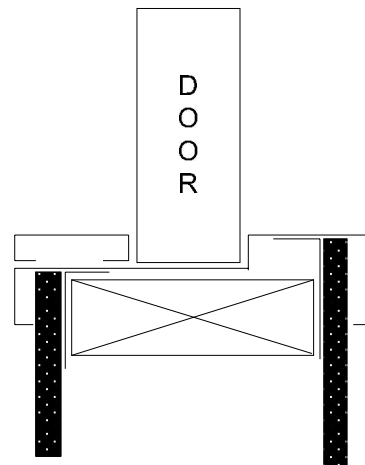

D - Strike Detail

## Welded Pocket Frame Detail (Sub-Frame by others) 1 of 2

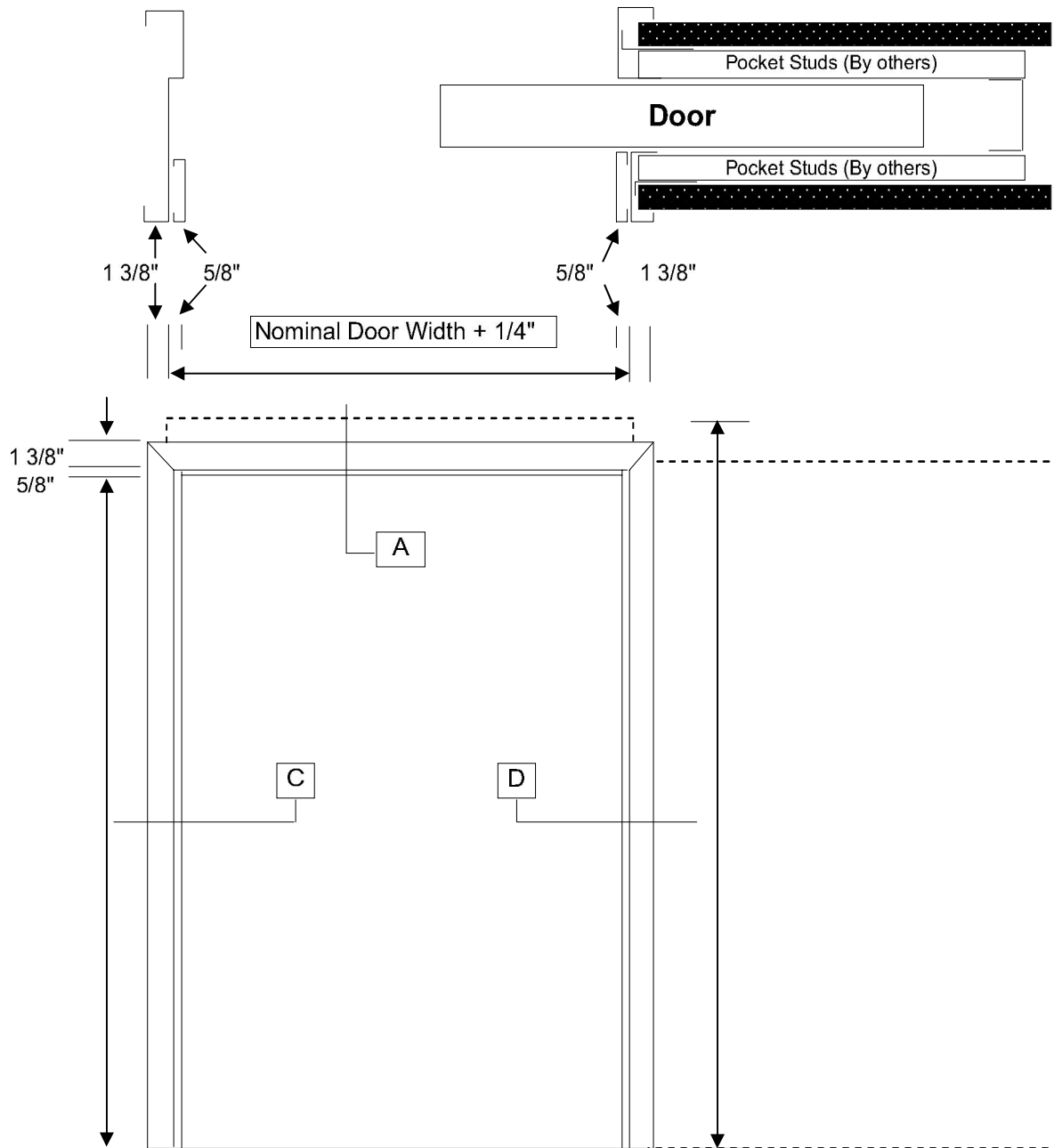

## Welded Pocket Frame Detail (Sub-Frame by others) 2 of 2

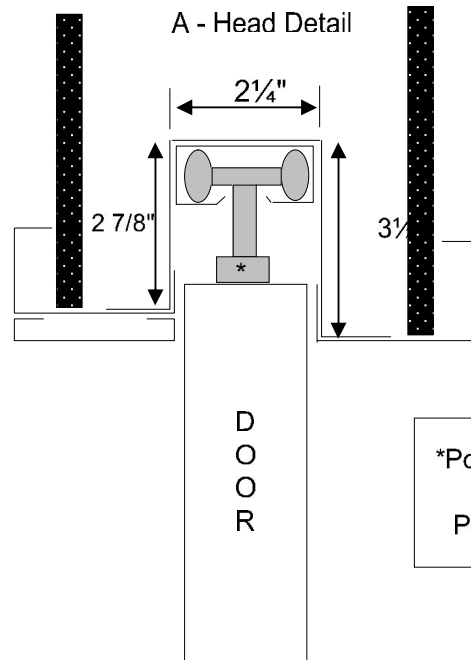

\*Pocket Track and Hardware available from HMF Express. Pocket Wall Stud Kit also available.

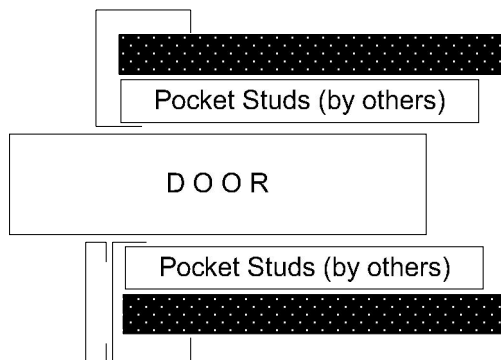

C-Receiver / Pocket Detail

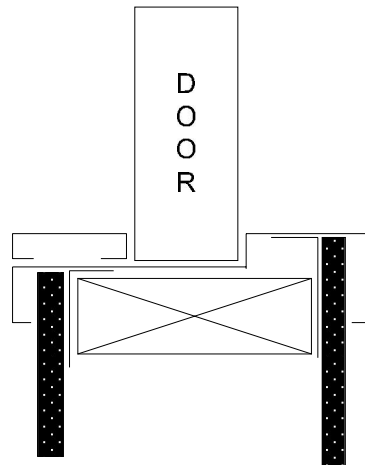

D-Strike Detail